

Cyber-Security Challenges for Smart Power Grids

Aranya Chakraborty
North Carolina State University

Internet2 Global Summit

May 26, 2017, Washington DC

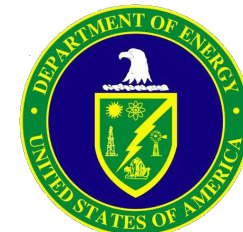

Why is Communication So Important for Controlling Power Systems?

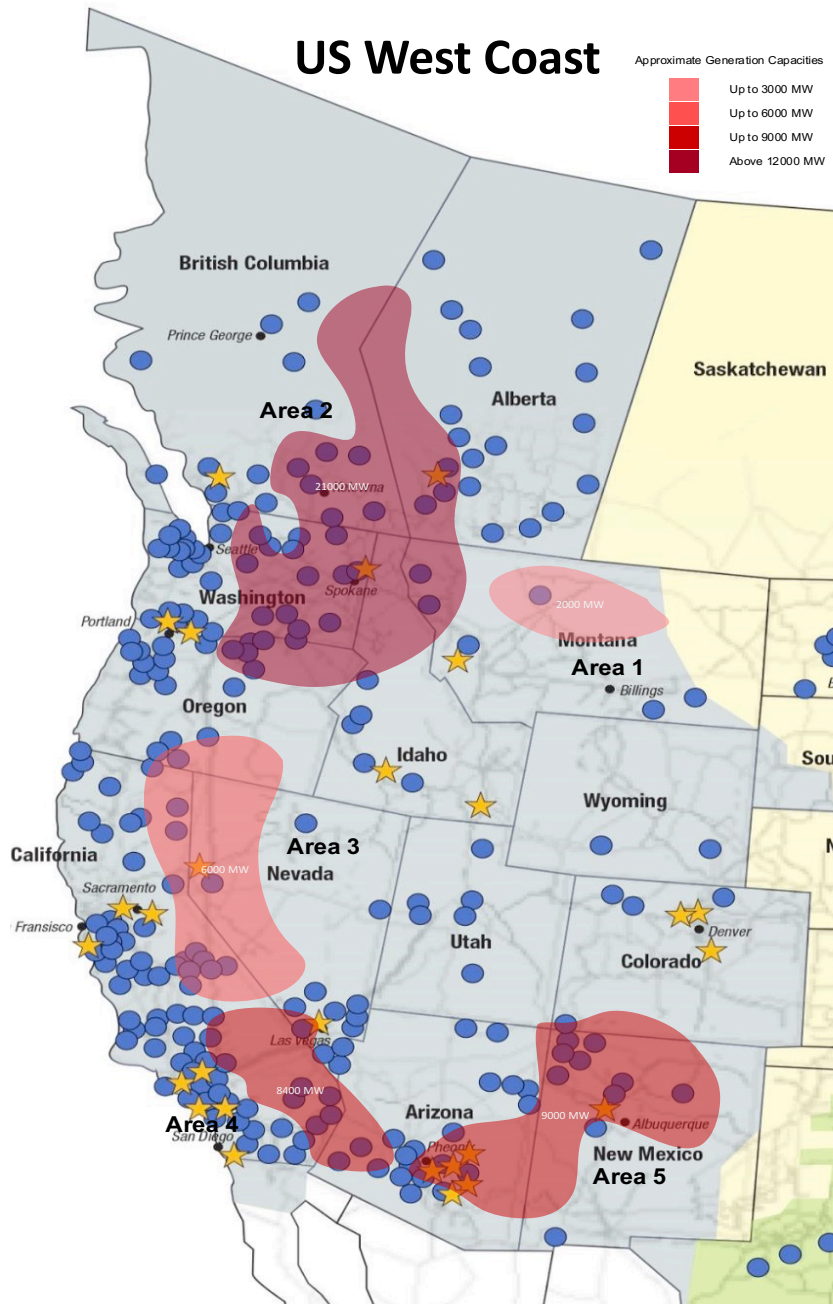

Why is Communication So Important for Controlling Power Systems?

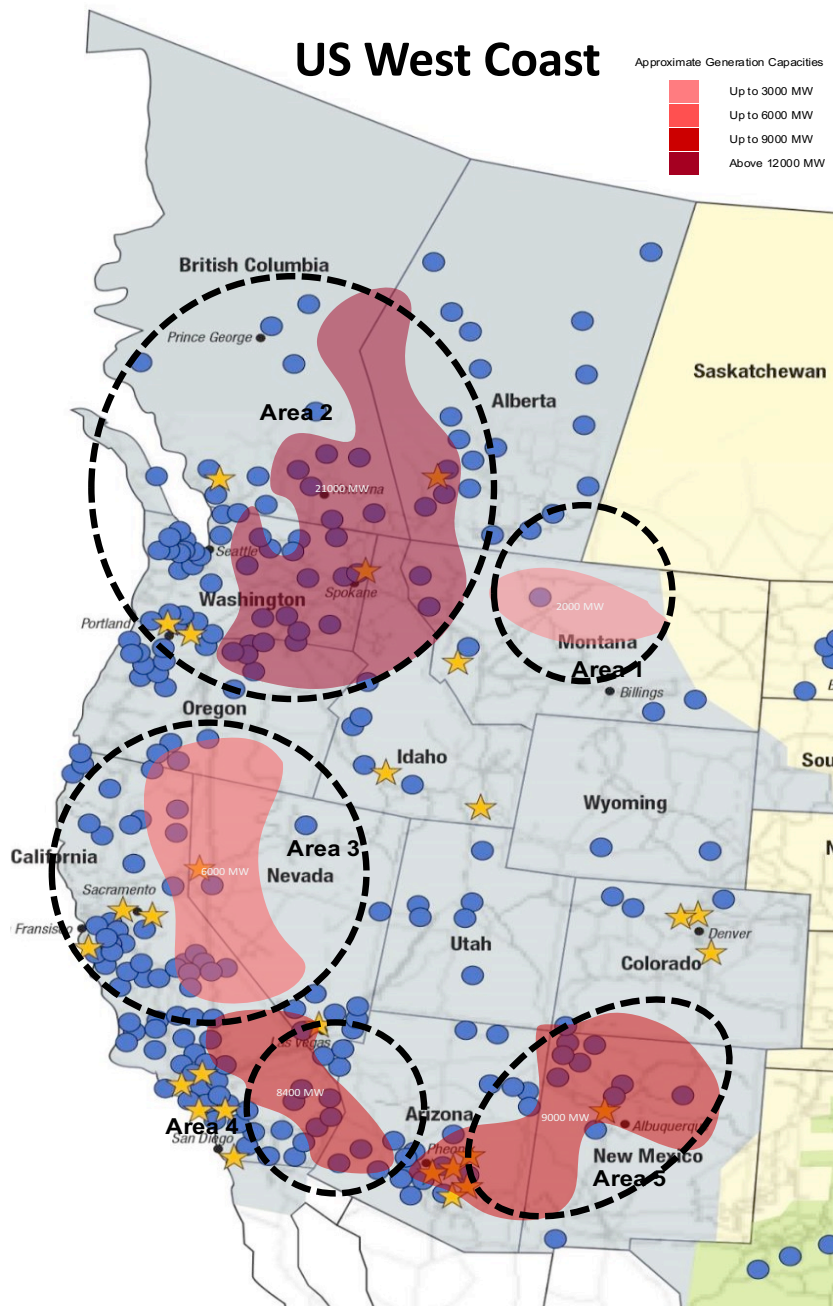

**Companies take control actions inside their regions
agnostic of the health of other parts of the grid**

Why is Communication So Important for Controlling Power Systems?

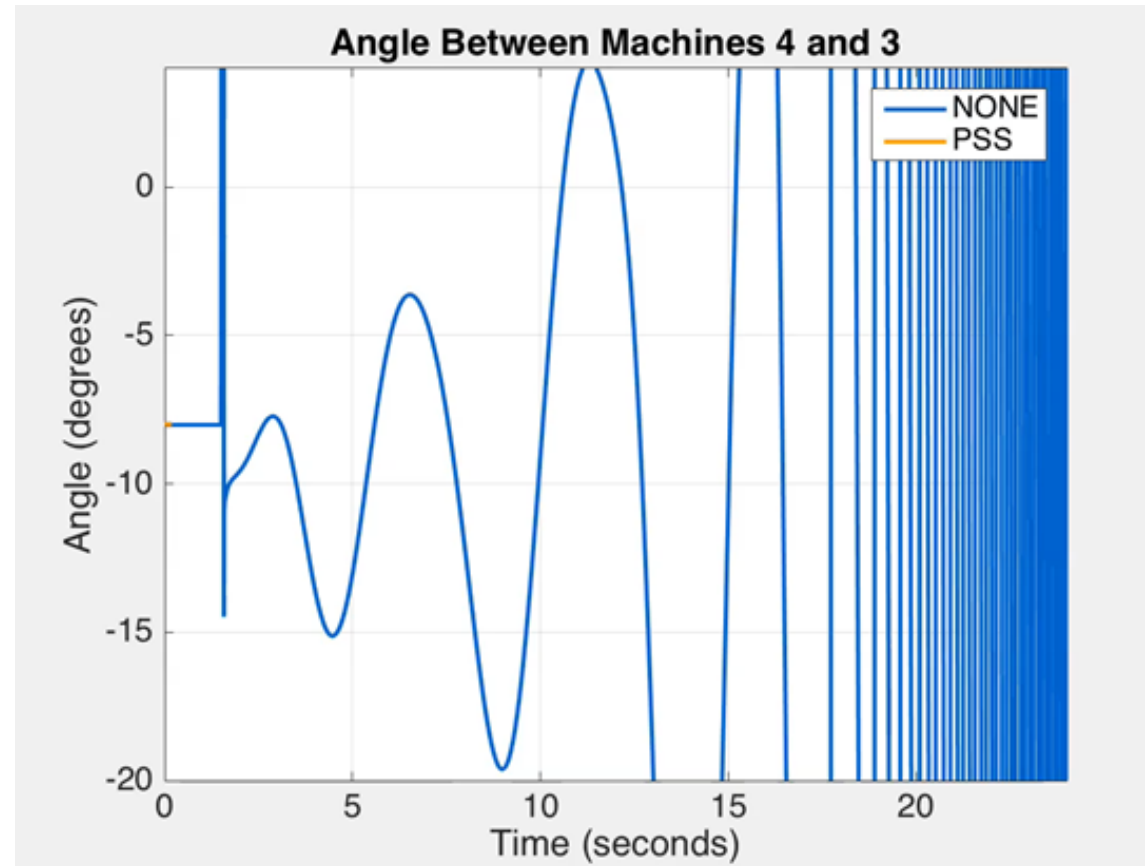
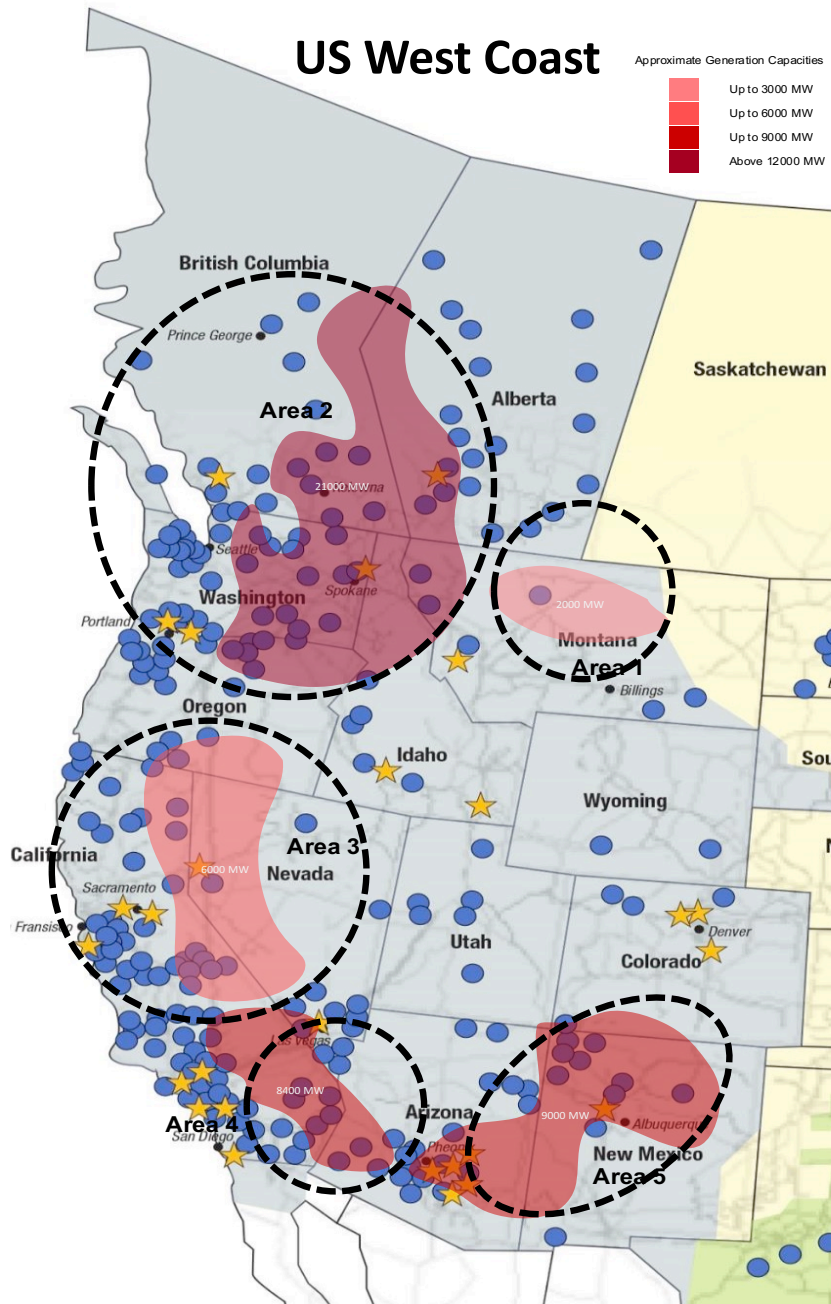

Why is Communication So Important for Controlling Power Systems?

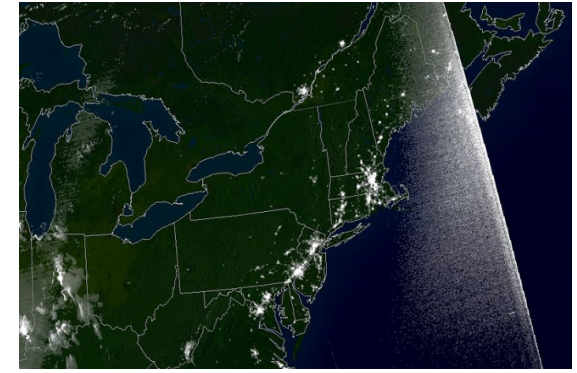
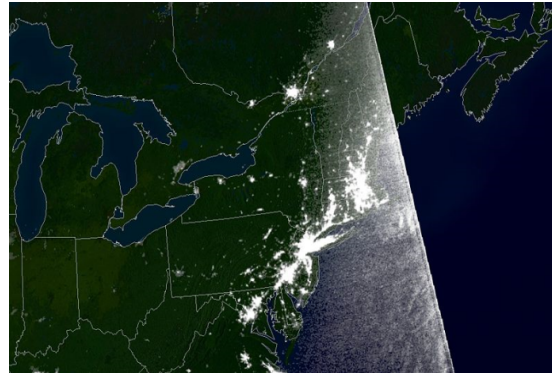
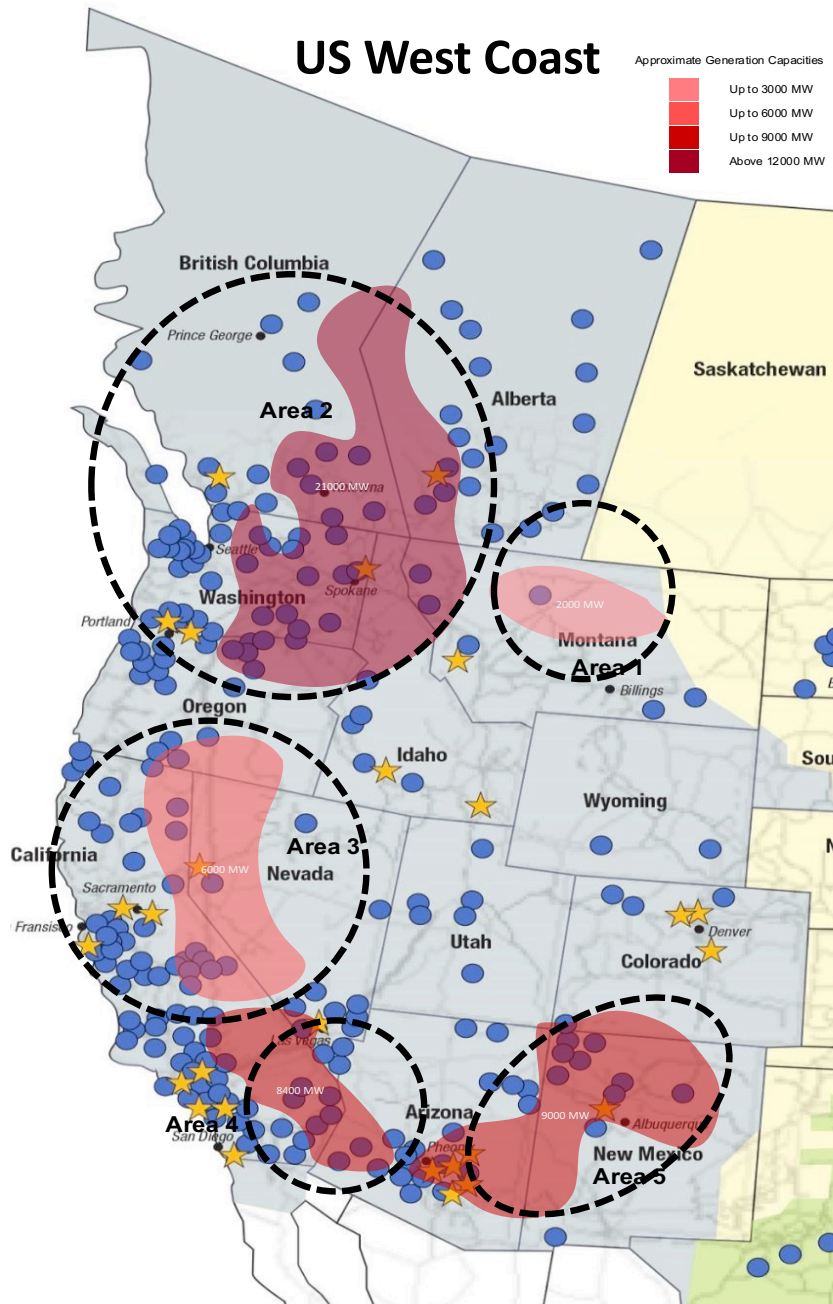

2003 Northeast blackout

Why is Communication So Important for Controlling Power Systems?

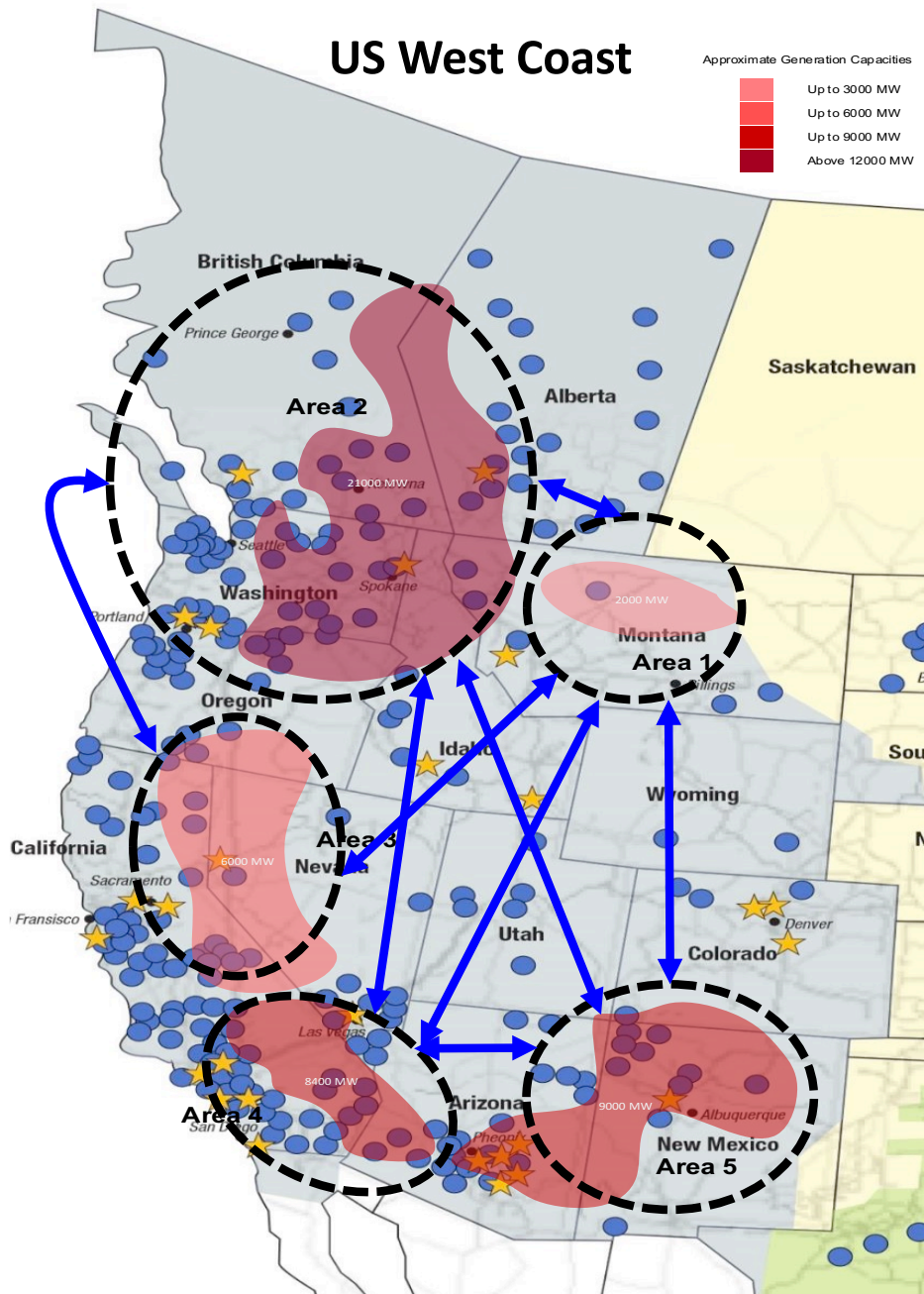

Balancing Regions are Sensitive to Data Privacy!

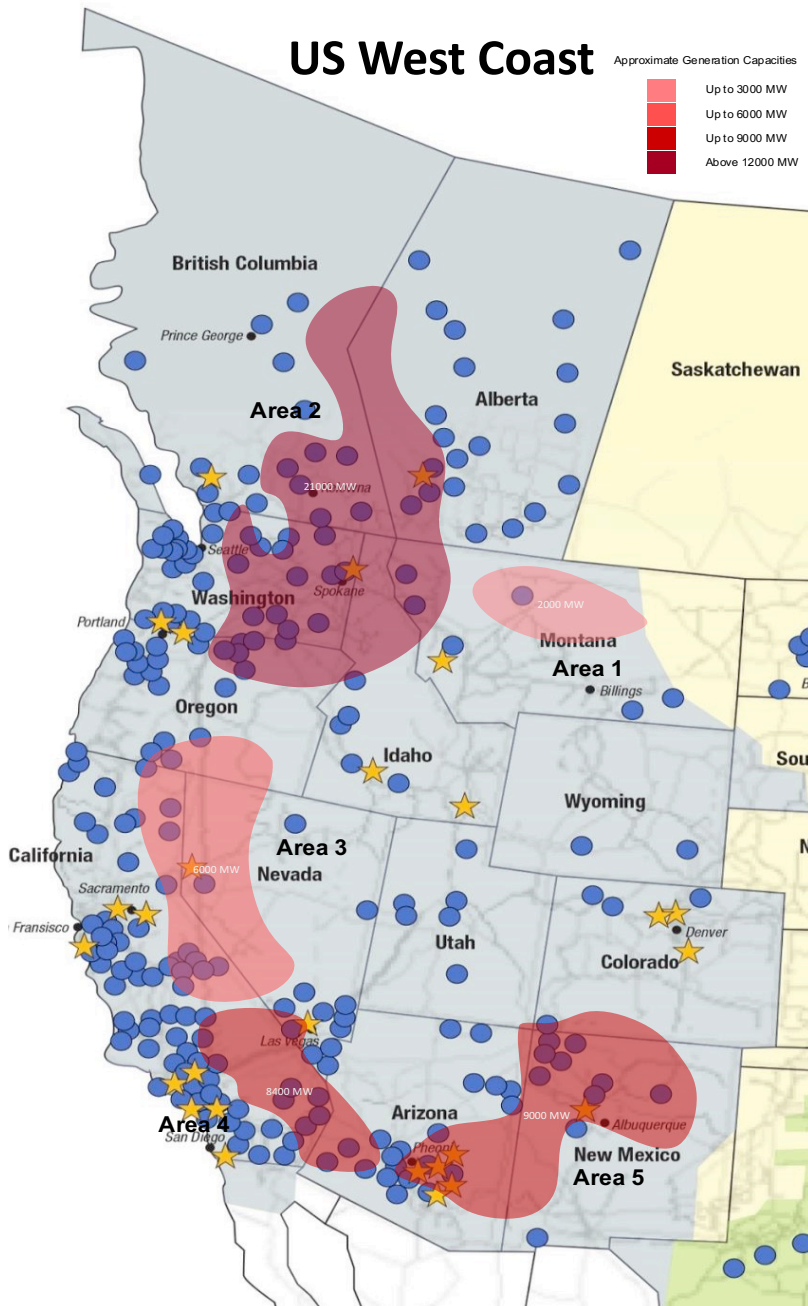

Close the loop from cloud to grid

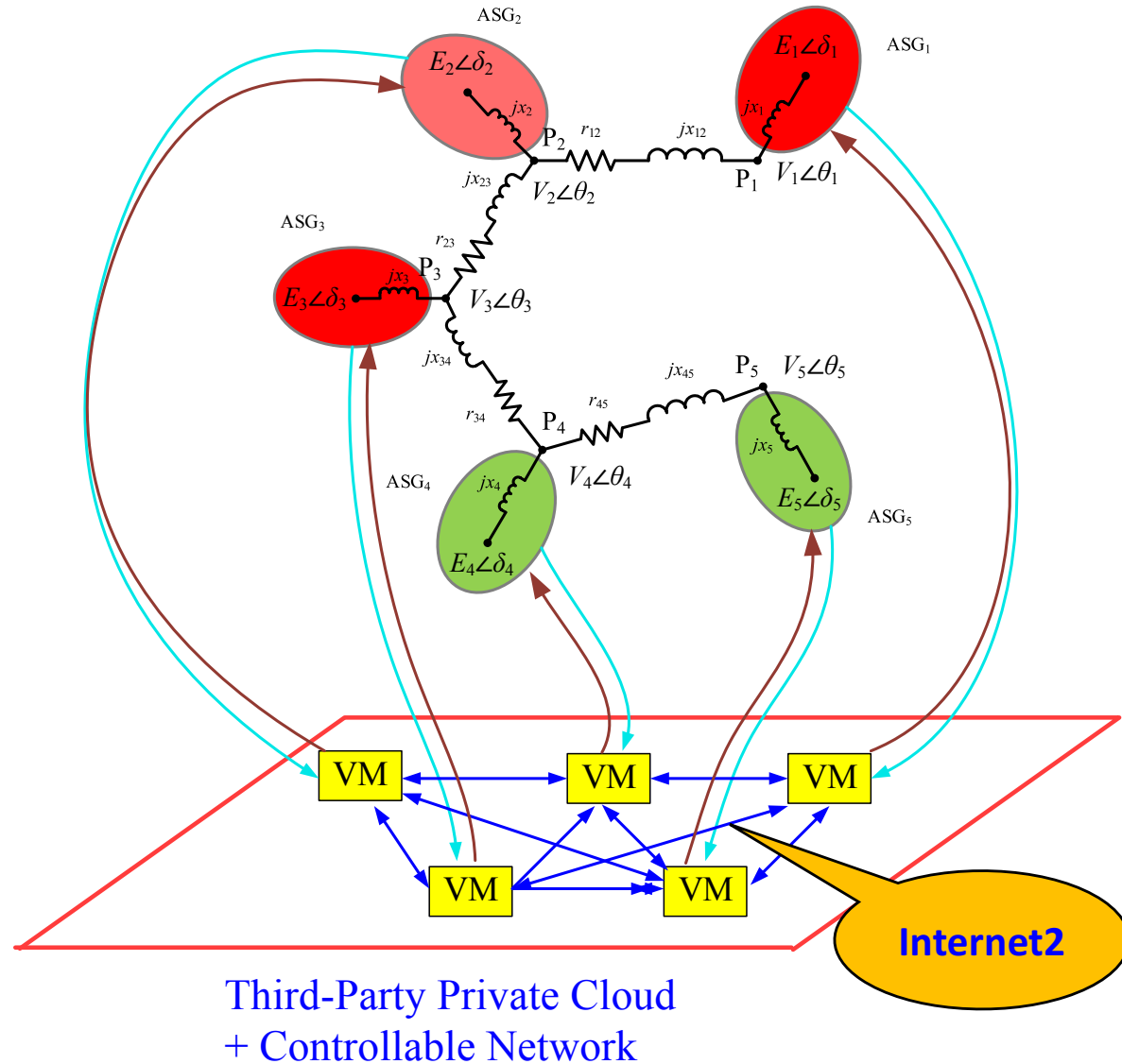

Interesting Things Going on in the Communication Plane

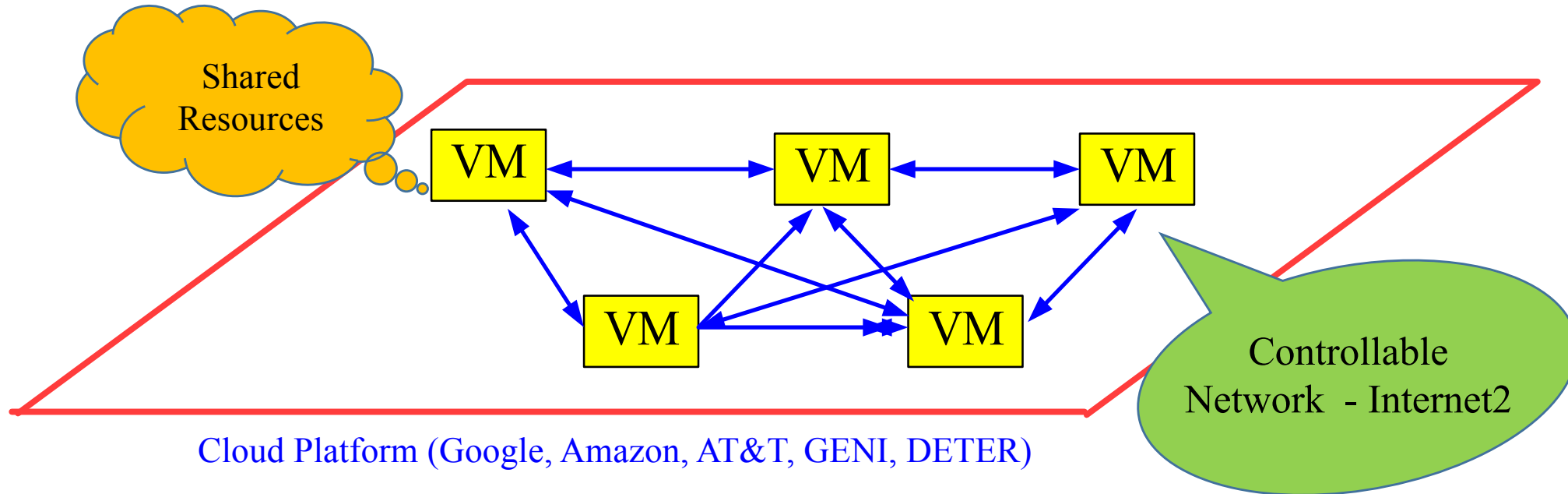

Different types of attacks:

1. Denial-of-Service
2. Data manipulation
3. GPS spoofing
4. Replay attacks

Denial-of-Service Attack

New England Power System Model
with LQR control

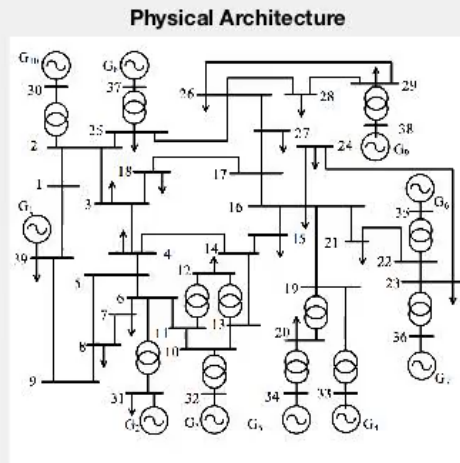

Status:
STABLE
(Dense)

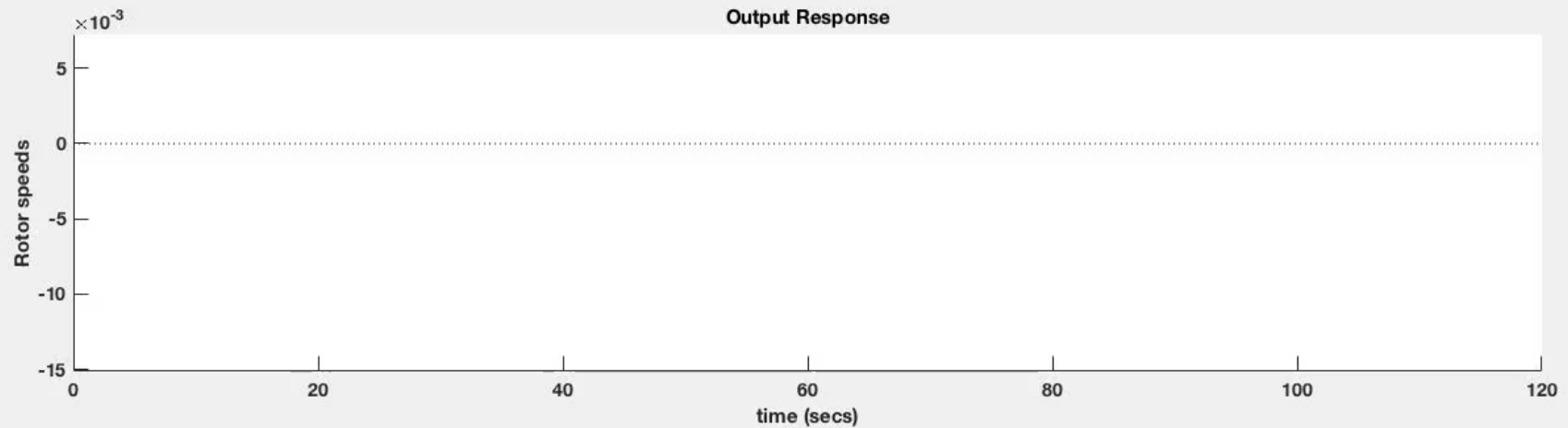
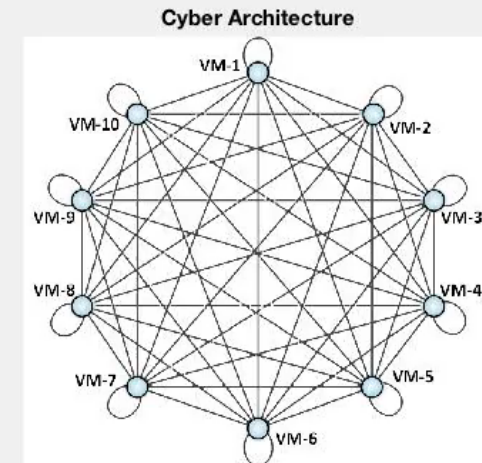

Denial-of-Service Attack

New England Power System Model
with LQR control

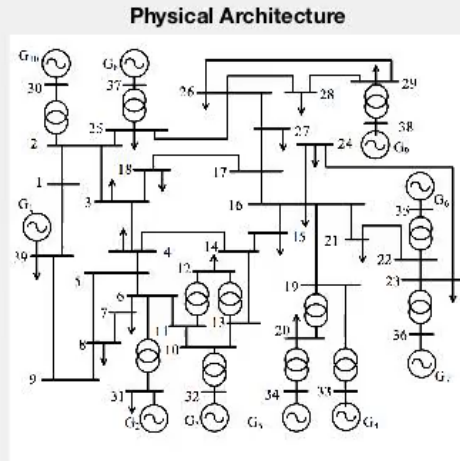

Status:
STABLE
(Dense)

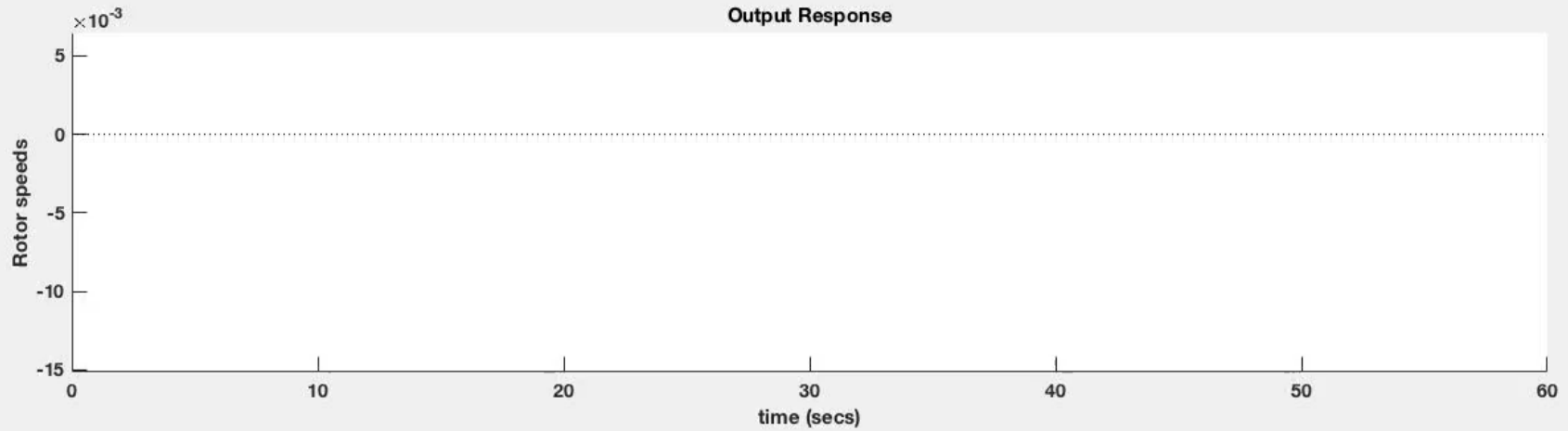
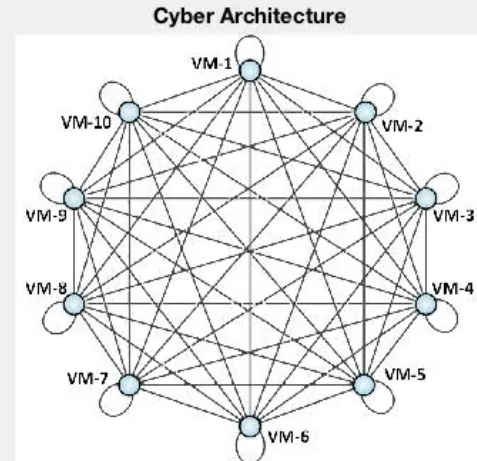

ExoGENI-DETER-WAMS Testbed at NC State

DoS Attack in DETER Testbed

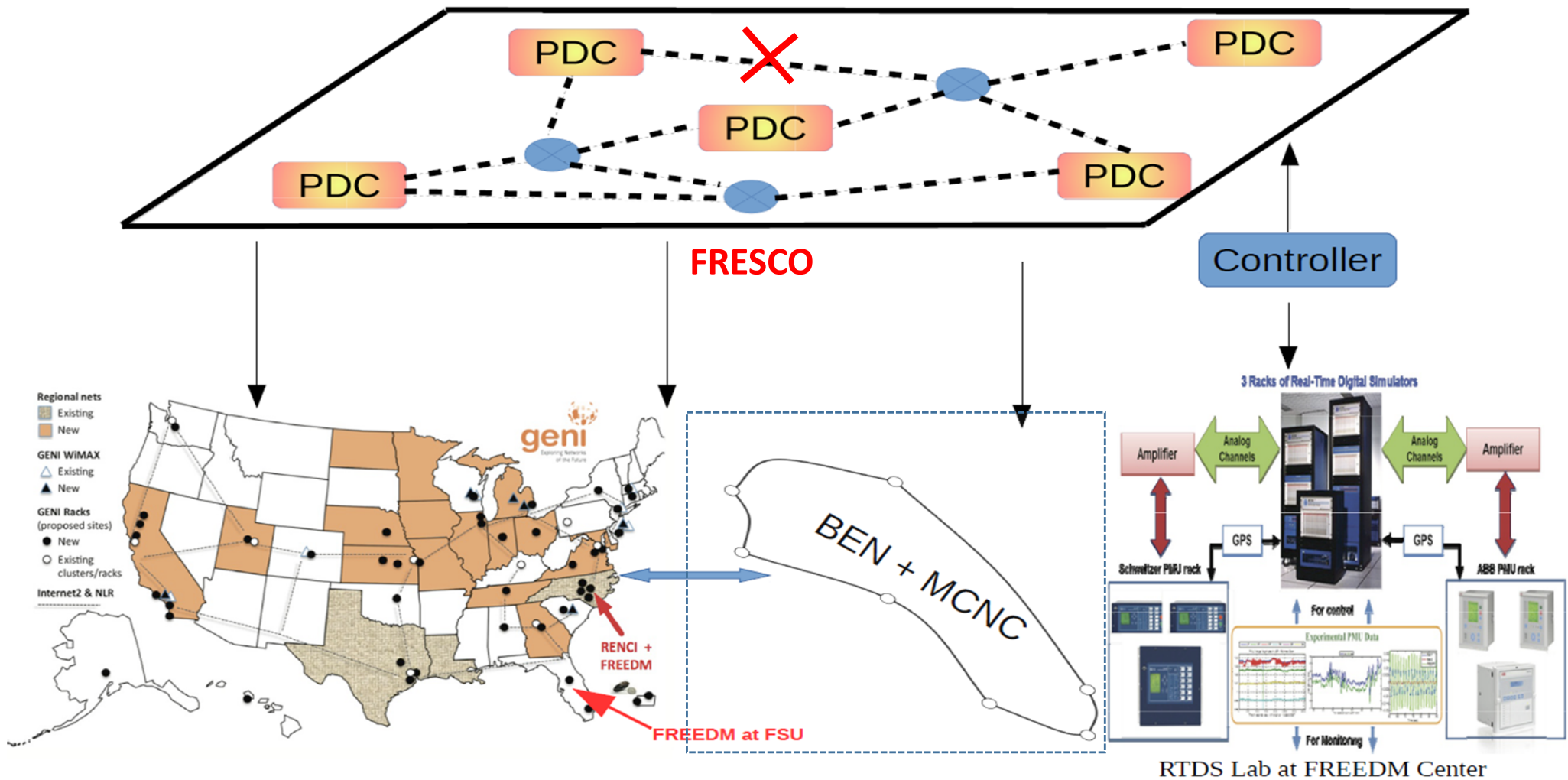

Middleware provided by Green Energy Corporation and RTI

Networked Cloud Computing Testbed - ExoGENI

ExoGENI provides in virtual IaaS services for innovative research on distributed applications for Wide-Area Monitoring and Control (14 rack sites at universities & labs over the US)

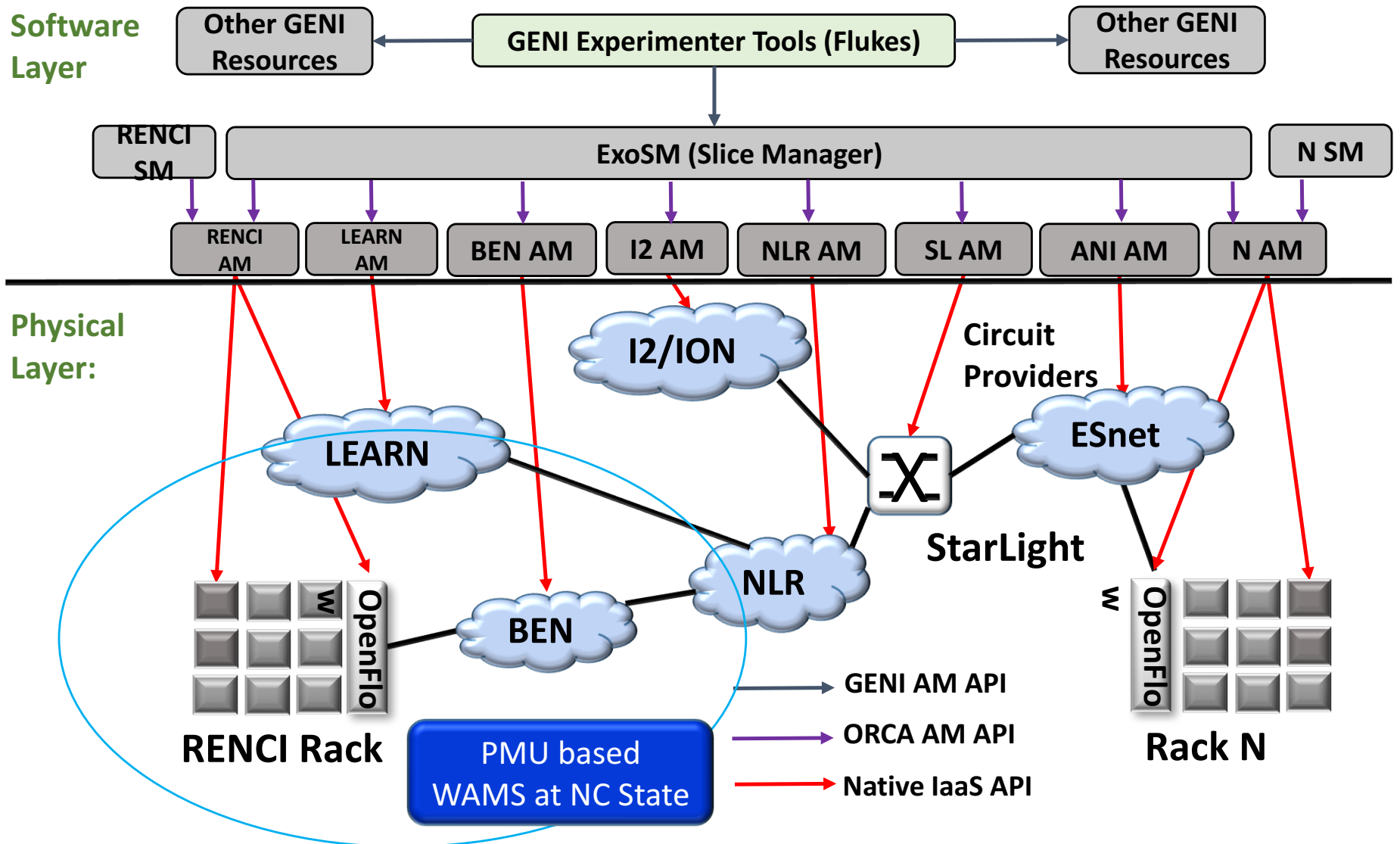

Project Impacts:



DETER Demo at NIST & Smart-America 2014

Best Energy App Award at US Ignite 2015

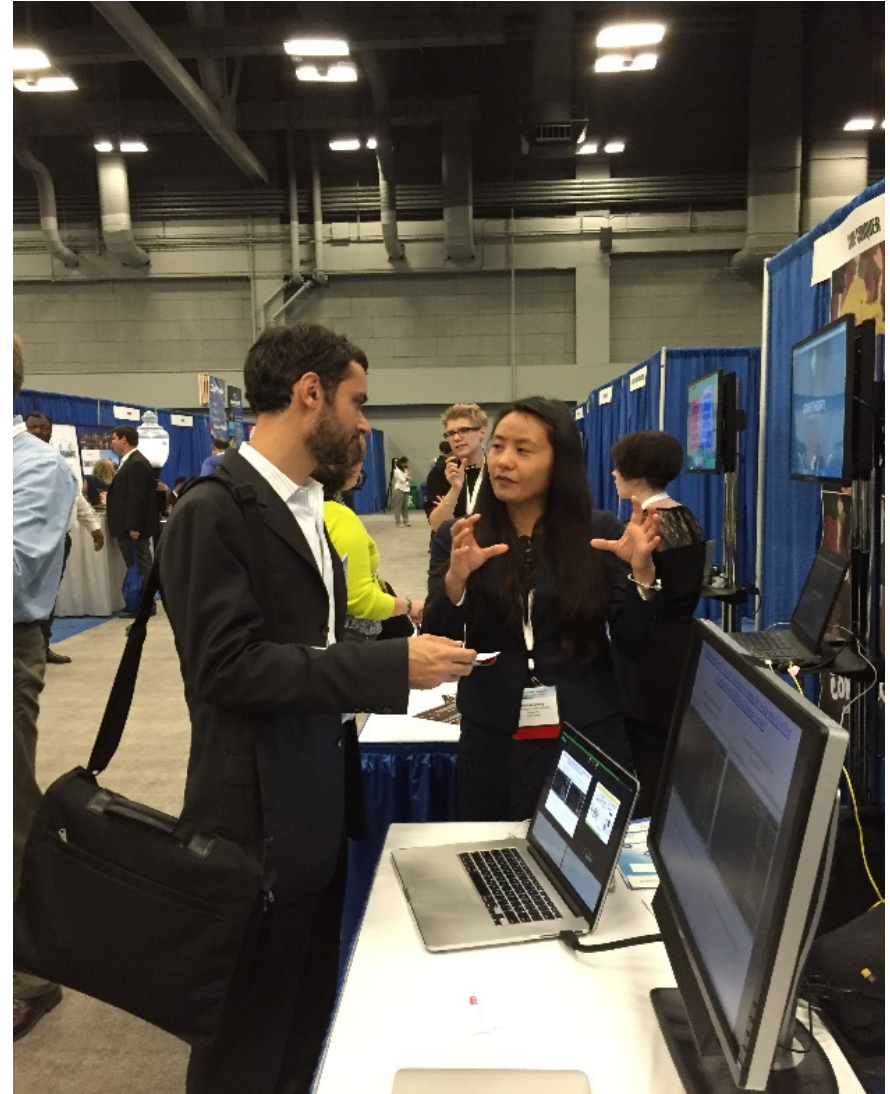
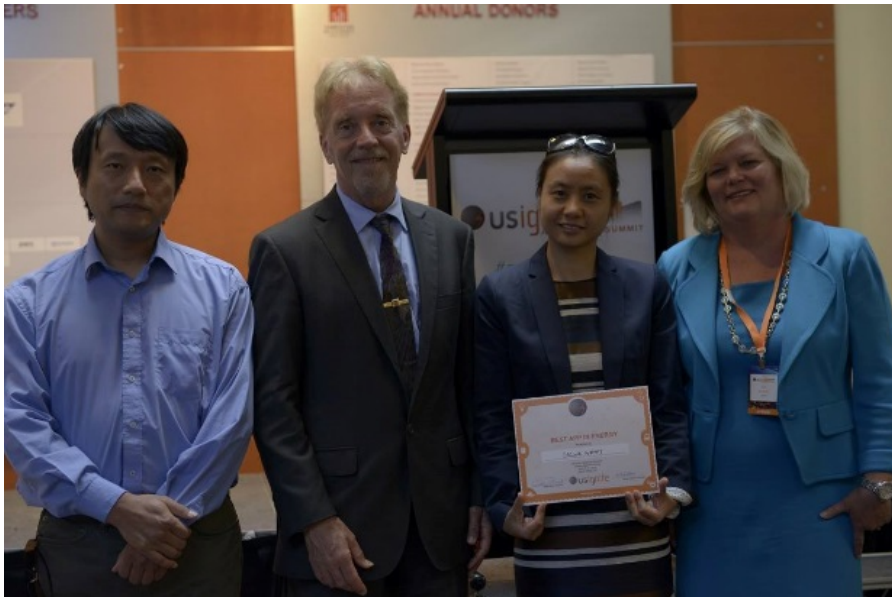

US Ignite & NIST
Smart Cities Application
Summit, Austin, TX, 2016

Thank You

Email: achakra2@ncsu.edu

Website: <http://people.engr.ncsu.edu/achakra2>